

New **TRIM TRIO**[®]



UTS series

IP68 / IP69K Plastic Connector

• Rapid

• Secure

• High Performance

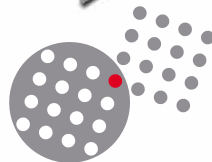

SOURIAU
Connection Technology



Company Profile

SOURIAU

Connectors and interconnect systems for harsh environments

The company designs, manufactures and markets high performance interconnect solutions for severe environments from industrial broadband and universal ranges to complex system with integrated functions: filtering, high speed data transmission, hermetic seal, separation mechanism, remote handling, underwater mating, ...



Industrial



Aeronautical



Equipment & system

The dedicated end markets for SOURIAU's products are aeronautical, defense-space and industrial



*Railway
Geophysics
Manufacturing environment
Instrumentation
Automation & process*



*Civil & military aircraft
Helicopter
Weapon delivery system
Avionics*



*Military marine
Communications
Satellites
Launcher & missile*

SOURIAU was established in 1917 and has been created by successive acquisitions of the industrial, aeronautical, defense and space activities of SOURIAU, JUPITER and BURNDY.

The Group's products are engineered and manufactured in the USA and Dominican Republic, Europe and Morocco, Japan and India, and sold by a worldwide sales and marketing organization, and in addition to SOURIAU's offices, a large network of licensed distributors and agents.

SOURIAU complies with most of national and international Quality Assurance Standards, production unit with ISO 14001

**Quality Certificate
Management System**

ISO 9001

**Environment Certificate
Management System**

ISO 14001

**Quality Certificate
Management System**

Aeronautic Industry : EN 9100

UTS



Contents

Company profile	2	Ergonomic plug.....	10
Contents	3	Backshells.....	10
Description	3	Sealing caps.....	10
Overview TRIM TRIO®	4	UTS	11-16
Major features & benefits	5-9	Technical characteristics.....	11
Contact styles.....	5	Cable plug.....	12
Rapid and secure locking system....	6	Jam nut receptacle.....	13
Rapid and trouble free service.....	6	PCB jam nut receptacle.....	14
Extreme sealing performance.....	7	Accessories.....	15
Contact arrangements.....	8	What sealing is....	16
Rapid and secure panel mounting...	9	Industrial applications.....	17
PCB receptacle.....	9		

Description

IP68 / IP69K plastic circular connector with rapid locking system

“UTS” is the latest addition to the well known TRIM TRIO® interconnect system.

‘UTS’ is a range of Industrial circular multiway connectors available in 3 shell sizes and 9 contact arrangements.

The keywords for the new UTS are: Rapid – Secure – High performance

• Rapid

Rapid refers to the locking system and the total installed cost starting with the wiring & cabling and ending with the installation to the customers equipment. Rapid also refers to the total service on price request, samples and production deliveries.

• Secure

The secure locking system together with the secure and versatile TRIM TRIO® contacts are giving confidence to both the connection and the customers equipment.

Moreover UTS is part of the well known TRIM TRIO® interconnect system with its more than 40 years of field experience.

• High Performance

Extreme performance on water protection even in dynamic situations this in combination with a rapid and secure locking system makes UTS suitable for any high performance application.

UTS provides a connection that performs faster, easier, safer and more reliable, it makes :

UTS : Your first choice in waterproof connectors !

UTS - Part of TRIM TRIO® interconnect system

Overview

UTS* series
Plastic
IP68
IP69K

UTO* series
Metal shielded
IP67/IP68
IP69K

UTG series
Metal locking
IP65

UTP series
Plastic
IP65

MBG series
Push pull
Min 5000
matings



Size16 contacts (1,6 mm)

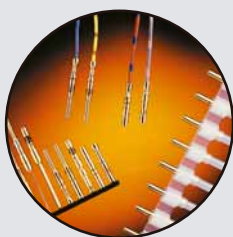

Machined

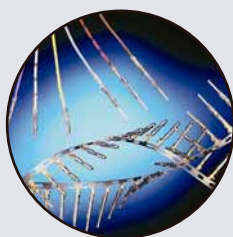

Stamped & formed

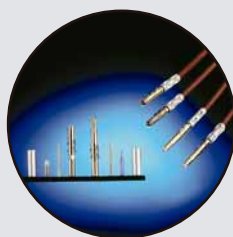

Coax**

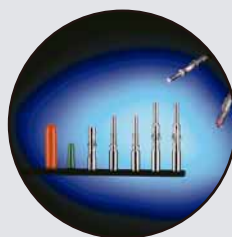

Fiber optic**



MSM/MS0series
Cable & boardmount
Jackscrew locking

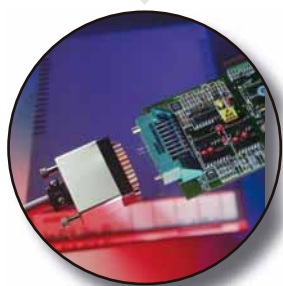

V.35 series
DTE/DCE
Modem interface

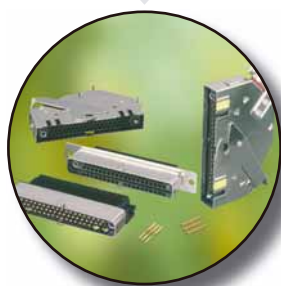

MSG/MB series
Cable & boardmount
Lever locking

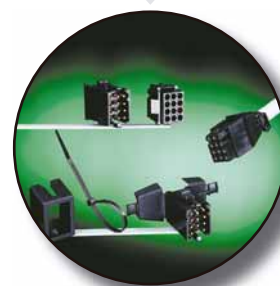

SMS series
Cable & boardmount
Rapid mating

* Size 20 available for UTO & UTS

** Coax & fiber optic available in #16

For more details about TRIM TRIO® connectors, refer to TRIM TRIO® catalogue or visit our website:
www.souriau.com → products → by connector type → TRIM TRIO®

UTS : Your first choice in waterproof connectors !

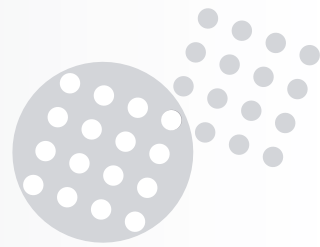

UTS - Major features and benefits



Different contact styles, selective loading, easy reparability, rapid crimping...rapid assembly

➤ TRIM TRIO® contacts - The most versatile and modular contacts concept

- Available in 4 different contact styles
- Suitable for field service and maintenance
- Combine all contact styles in same connector
- Established for more than 40 years

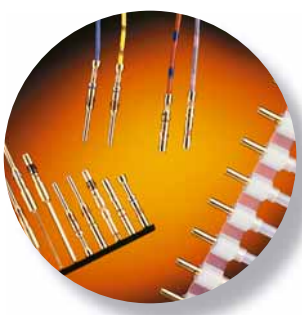

Machined



Stamped



Coax

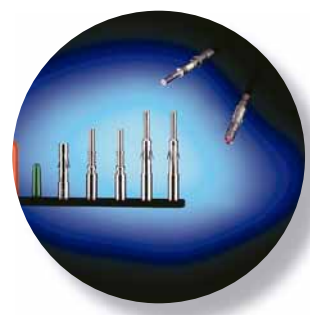

Fiber optic

➤ Rapid crimping with TRIM TRIO® contacts

- Reliable and trouble free crimping
- Hand tools for maintenance and production
- Semi automatic bench press & applicators
- Stripper crimpers
- Contacts to be ordered separately
- Refer to TRIM TRIO® catalogue



➤ Rapid assembly of contacts

- Push the contact in the cavity until it clicks»
- Selective loading
- Easy to repair

➤ Rapid assembly of backshell

- Limited number of components
- Integrated cable gland
- Backshell suitable for a wide range of cables

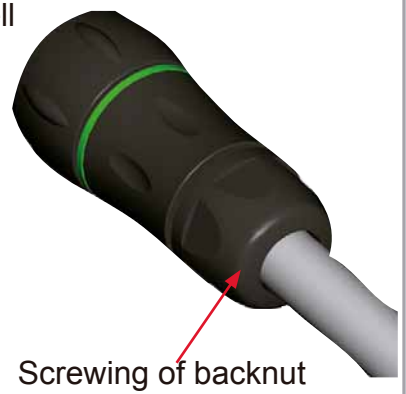
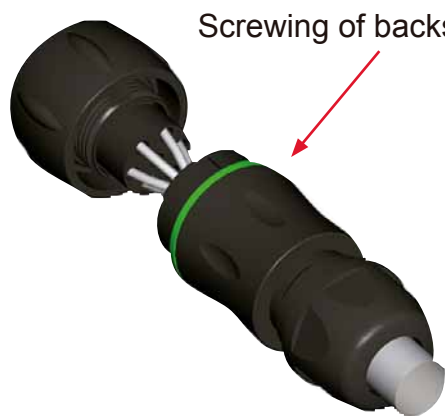
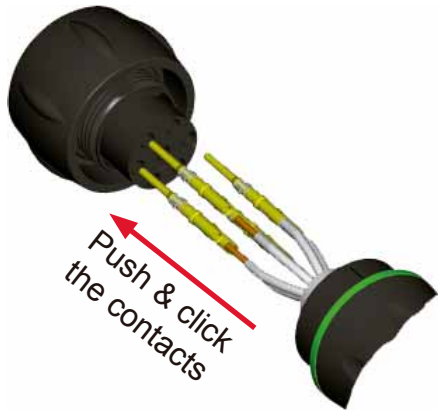

UTS : Your first choice in waterproof connectors !

UTS - Major features and benefits



Rapid and secure locking system

- ➡ Confidence that the connector is properly mated
- ➡ Easy to connect in difficult places
- ➡ Minimalised operator fatigue
- ➡ Labor saving

Rapid mating with 1/3 turn with an audible & sensitive "click"

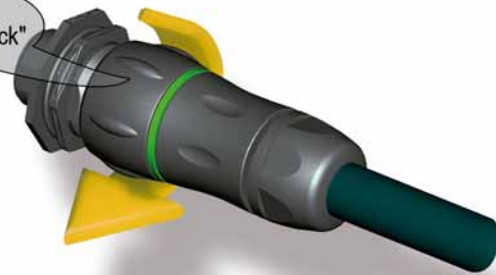

Rapid and trouble free service

- ➡ Fast delivery of samples, quotes and production volumes

Worldwide network of:

- Sales units
- Distributors
- Agents



UTS : Your first choice in waterproof connectors !



UTS - Major features and benefits



Extreme environmental sealing performance

➔ IP68 / IP69K sealing ... even in dynamic situations

➔ Dynamic IP68*

Connector will remain IP68 even when:

- Pulling on the cable
- Bending the cable

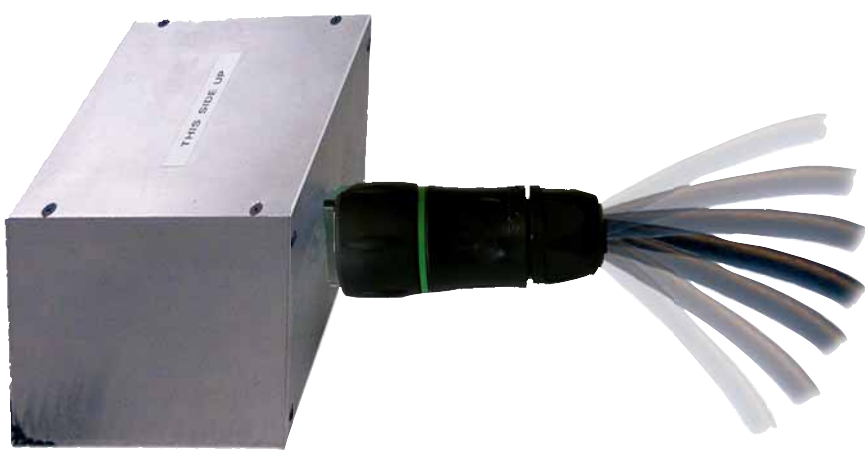

➔ Dynamic IP69K*

Connector withstands high pressure water cleaning

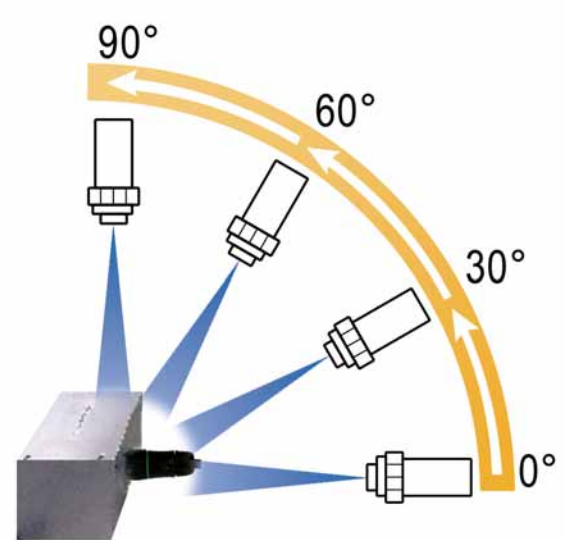

* See table page 16 for more details

UTS : Your first choice in waterproof connectors !

UTS - Major features and benefits

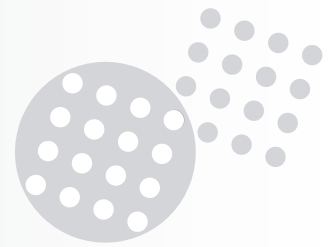

Multiple contact arrangements with VDE 0110 performances

- **Multiple contact arrangements within same connector size**
 - Different levels of current and rated voltages per VDE 0110
 - Available in male and female gender
 - Custom version upon request such as:
 - Mixed contact sizes
 - Power versions
 - High speed versions (RJ45, USB, BNC), upon request

- **UTS insert arrangements, contact size, rated voltage per VDE 0110 & current ratings**

Contact size	# 16 (dia. 1.6mm)		#20 (dia. 1.0mm)
Rated voltage	250 V	125 V	125 V
Overvoltage category	III	III	III
Pollution degree	3	3	3
Size 10	*		
Number of contacts	3 (2+ grounding)	4	6
Max current (per contact)	13A (machined + stamped)	13A (machined + stamped)	7.5A (machined) / 5A (stamped)
Size 12	*		
Number of contacts	4 (3 + grounding)	8	10
Max current (per contact)	13A (machined + stamped)	13A (machined + stamped)	7.5A (machined)/ 5A (stamped)
Size 14	*		
Number of contacts	7 (6 + grounding)	12	19
Max current (per contact)	13A (machined + stamped)	13A (machined + stamped)	7.5A (machined)/ 5A (stamped)

* Arrangements with advanced grounding cavity.

UTS : Your first choice in waterproof connectors !



UTS - Major features and benefits



Rapid and secure panel mounting

Rear panel mount solution suitable for pre-harnessing and PCB mounting

Captive panel seal to prevent misalignment

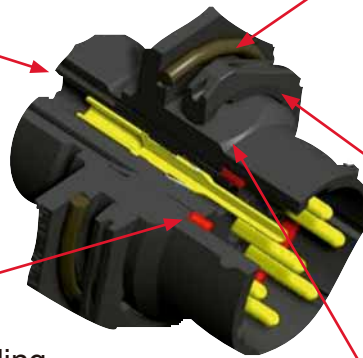

Robust jam nut to guarantee a rapid, secure and vibration proof panel mounting

O-ring seal to guarantee sealing between receptacle and plug

D-shape panel cut to ensure correct mounting and to prevent the connector from rotating

Assembly procedure of jam nut receptacle

Step 1

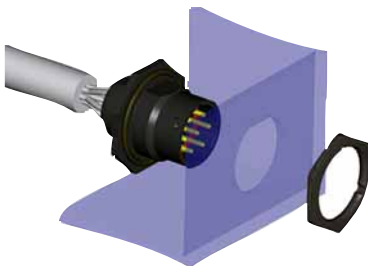

Step 2

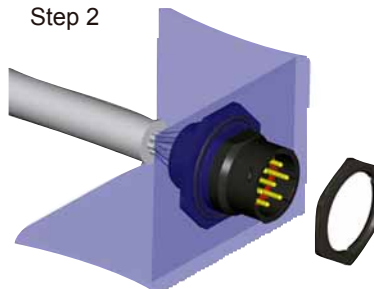

Step 3

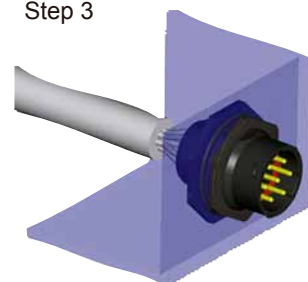

PCB receptacle...low profile with rapid installation features

Low profile housing to limit space between panel and PCB

Metal hold down clips

- to lock the connector easily on the PCB and to release stress on solder joints
- Suitable for soldering in a metallised hole

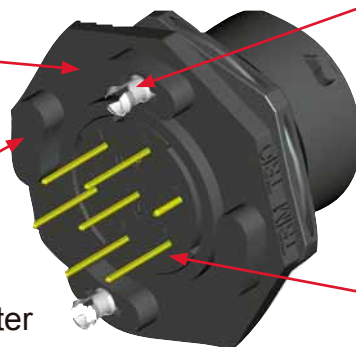

Pre-assembled PCB contacts

- machined or stamped versions available
- different solder tails lengths possible
- different plating options

Stand-offs to allow cleaning after soldering

UTS : Your first choice in waterproof connectors !

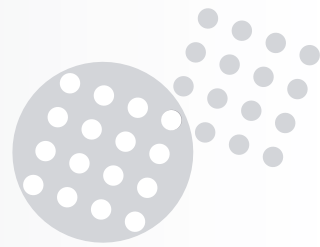

UTS - Major features and benefits



Ergonomic plug design with maximized cabling space and minimized connector length

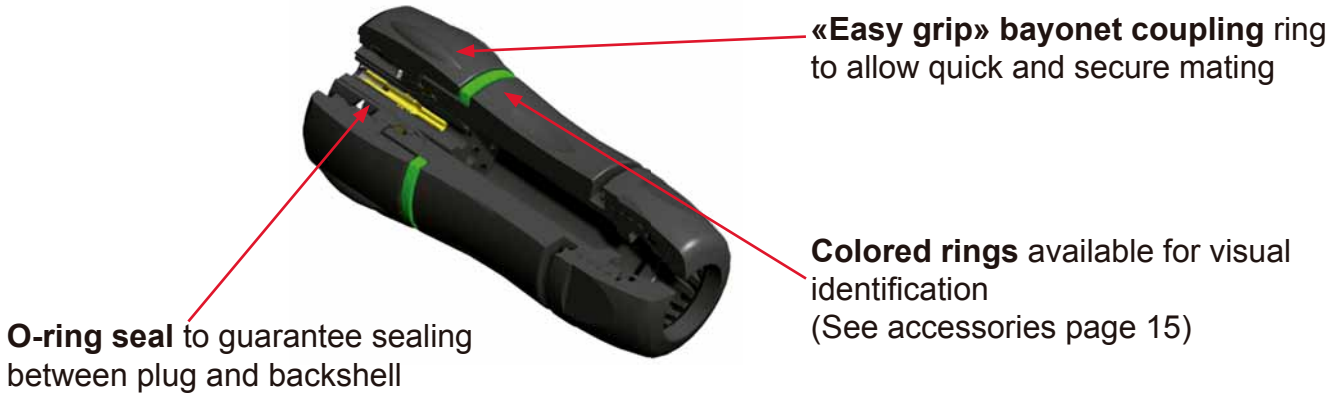

Backshells...accepting a wide range of cables

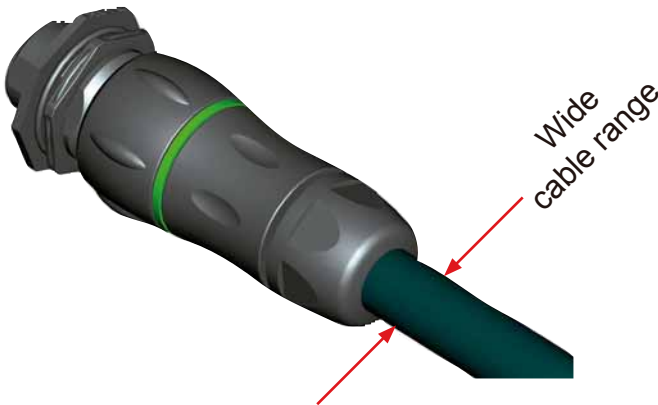

Size 10	2.5 to 8.0 mm
Size 12	3.0 to 12.0 mm
Size 14	5.0 to 14.0 mm

Low installed cost with reduced number of components



Sealing caps...easy to install...at any time

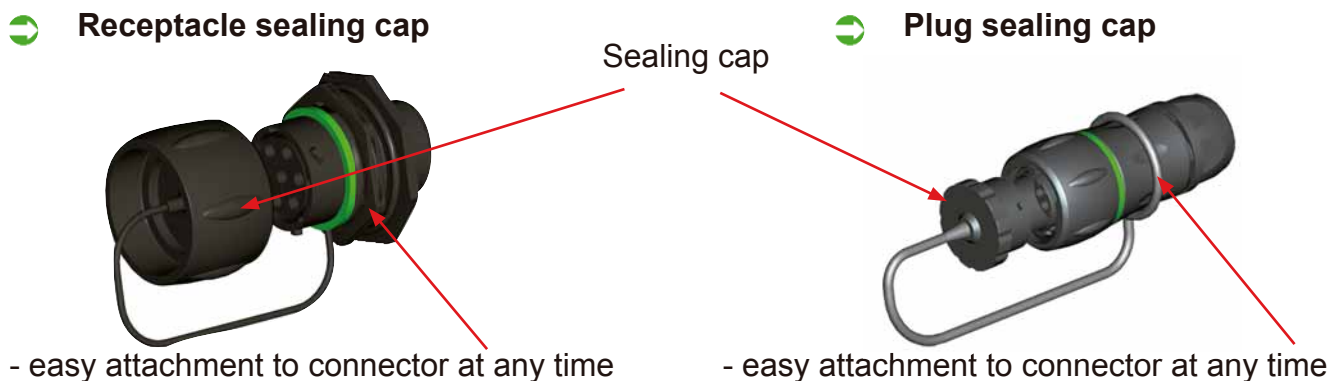

UTS : Your first choice in waterproof connectors !

UTS



Technical characteristics

MECHANICAL

- Durability: 250 matings & unmatings
- Vibration resistance: Per CEI 60512-4
- Thermal shock: Per MIL-STD1344 method 1003

ELECTRICAL

- Insulation resistance: 5000 MΩ min
- Test potential: 2000 VAC
- As per VDE specifications (see page 8 for more details)

ENVIRONMENTAL

- Operating temp: -40°C to + 105°C
- Flammability rating: UL94V0 and NFF16101 level 2
- Sealing (mated): Dynamic IP68 – 10m under water for 1 week per IEC60529
Dynamic IP69K per DIN40050
- UV resistant: No mechanical degradation or important variation of color after 5 years of exposure in natural environment (equivalence exposure to sun and moisture as per ISO 4892)
- Salt spray: 500 hours

MATERIAL

- Connectors + Backshell: Thermoplastic



PLATING (only for PCB version)

- Plating for machined contacts: min 0.4 μ gold all over
- Plating for stamped contacts: Min 0.4 μ gold in contact area
3 – 5 μ tin on solder tail

Other platings upon request

CONTACT ACCOMMODATION

- “UTS” connectors accept TRIM TRIO® size 16 or size 20 (depending on arrangement) removable snap-lock contacts
- Contacts to be ordered separately (except PCB versions)
- Refer to TRIM TRIO® catalog for details or visit our website:

www.souriau.com → products → by connector type → TRIM TRIO® → contacts

In accordance with UL requirements

UTS : Your first choice in waterproof connectors !

UTS

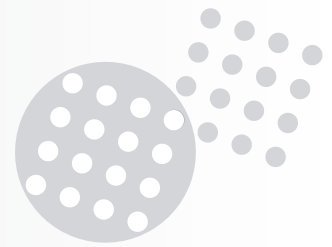

Cable plug with backshell for pin and socket contacts (UTS6JC...P / UTS6JC...S)

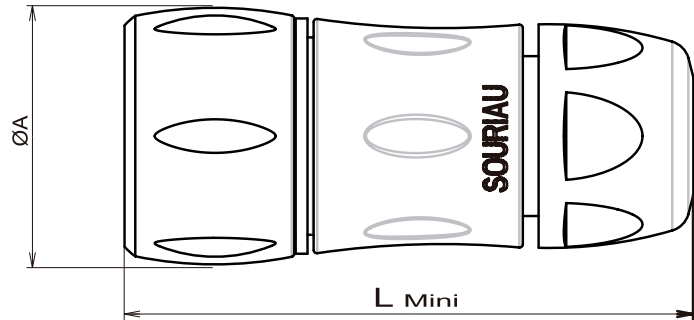

Each plug has 2 seals to cover the specified cable range (See table below).
The standard seal is preassembled
The second seal is supplied as loose piece together with a plug.

PN pin contact	PN socket	Nb of contacts x contact Ø	Shell size	L	Ø A	Ø Cable range
UTS6JC103P	UTS6JC103S	3 x 1.6 mm	10	63.2	26.2	1.5 to 5.0 2.5 to 8.00 (standard)
UTS6JC104P	UTS6JC104S	4 x 1.6 mm				
UTS6JC106P	UTS6JC106S	6 x 1.0 mm				
UTS6JC124P	UTS6JC124S	4 x 1.6 mm	12	66.7	29.7	3.0 to 9.0 5.0 to 12.0 (standard)
UTS6JC128P	UTS6JC128S	8 x 1.6 mm				
UTS6JC1210P	UTS6JC1210S	10 x 1.0 mm				
UTS6JC147P	UTS6JC147S	7 x 1.6 mm	14	71.5	34.6	5.0 to 12.0 7.0 to 14.0 (standard)
UTS6JC1412P	UTS6JC1412S	12 x 1.6 mm				
UTS6JC1419P	UTS6JC1419S	19 x 1.0 mm				

For more detail on contact arrangements, see page 8.
Coloured ring supplied as optional extra (See page 15).
Contacts to be ordered separately.

For more details about TRIM TRIO® connectors, refer to TRIM TRIO® catalogue or visit our website:
www.souriau.com → products → by connector type → TRIM TRIO® → contacts

*Note: All dimensions are in mm.
Dimensions are not contractual and may be subject to modifications.*

UTS : Your first choice in waterproof connectors !

UTS



Jam nut receptacle (wire version) for pin and socket contacts (UTS7...P / UTS7...S)

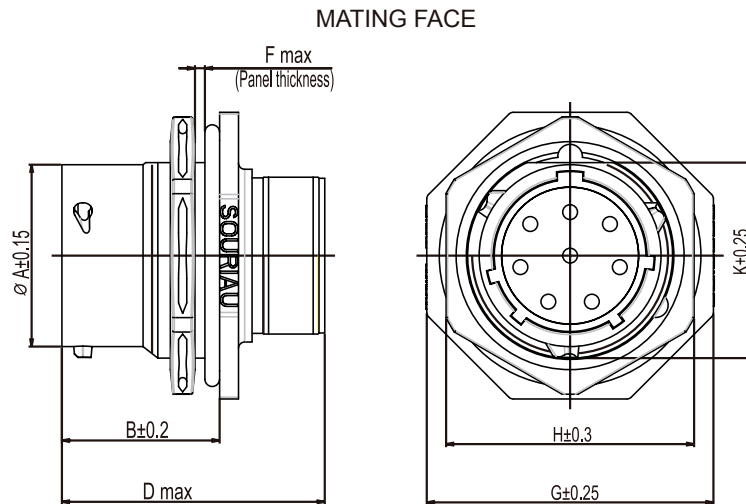

PANEL CUT OUT

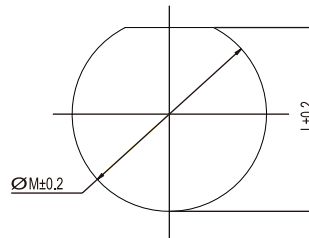

PN pin contact	PN socket	Nb of contacts x contact \varnothing	Shell size	$\varnothing A$	B	D Max	F Max	G	H	K	L	$\varnothing M$
UTS7103P	UTS7103S	3 x 1.6 mm	10	14.9	19.3	33.9	3.2	27.0	22.2	16.6	16.5	17.7
UTS7104P	UTS7104S	4 x 1.6 mm										
UTS7106P	UTS7106S	6 x 1.0 mm										
UTS7124P	UTS7124S	4 x 1.6 mm	12	19.0	19.3	33.9	3.2	31.8	27.0	20.8	21.2	22.5
UTS7128P	UTS7128S	8 x 1.6 mm										
UTS71210P	UTS71210S	10 x 1.0 mm										
UTS7147P	UTS7147S	7 x 1.6 mm	14	22.2	19.3	33.9	3.2	34.9	30.2	23.9	24.3	25.7
UTS71412P	UTS71412S	12 x 1.6 mm										
UTS71419P	UTS71419S	19 x 1.0 mm										

For more detail on contact arrangements, see page 8.

Coloured ring supplied as optional extra (See page 15).

Contacts to be ordered separately.

For more details about TRIM TRIO® connectors, refer to TRIM TRIO® catalogue or visit our website:
www.souriau.com → products → by connector type → TRIM TRIO® → contacts

Note: All dimensions are in mm.

Dimensions are not contractual and may be subject to modifications.

For free hanging applications, connector can be equipped with the same backshell as for the plug (please consult us).

UTS : Your first choice in waterproof connectors !

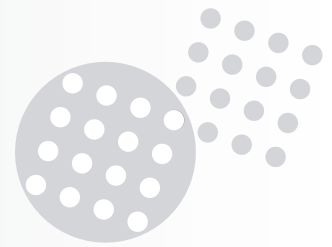

PCB jam nut receptacle for male contacts

UTS7147PSEK9

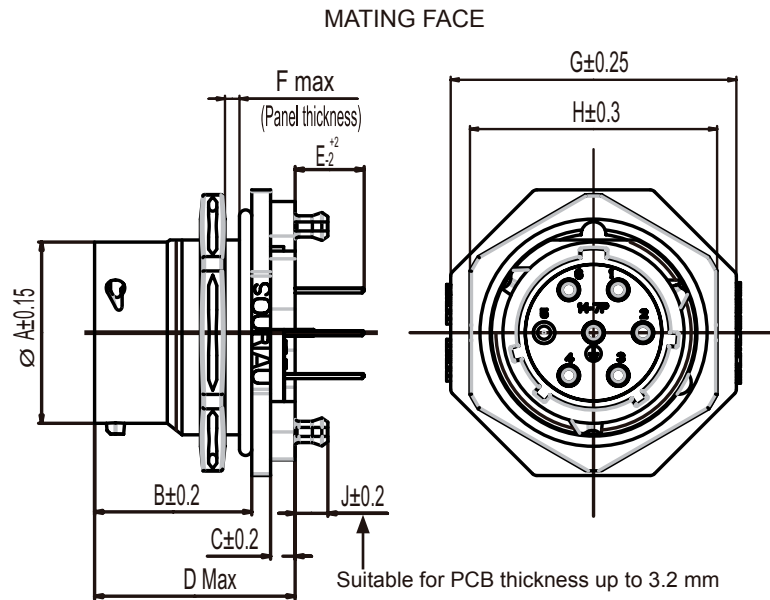

DRILLING PATTERN

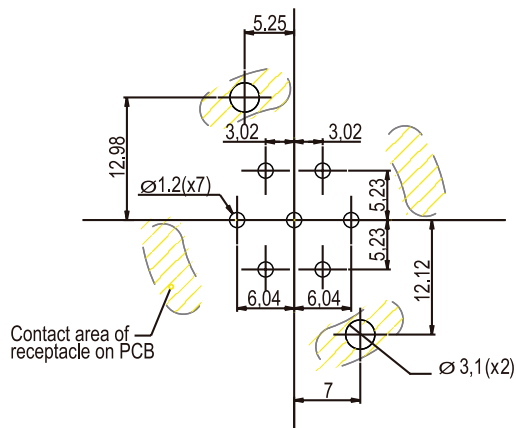

PANEL CUT OUT

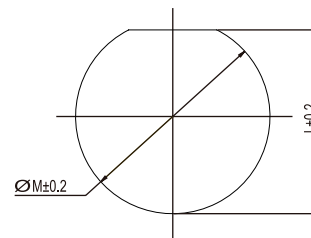

Shell size	Ø A	B	C	D Max	E	F	G	H	J	L	Ø M
14	22.2	19.3	3	24.5	3.6	3.2	34.9	30.2	4	24.3	25.7

Other arrangements upon request.

Stamped and formed contacts.

Plating:

K9 (std) = Min 0.4µ Gold in contact area,
3 - 5µ Tin on solder tail

T = 3 - 5µ Tin all over

Note: All dimensions are in mm.

Dimensions are not contractual and may be subject to modifications.

UTS : Your first choice in waterproof connectors !



Accessories

Receptacle sealing cap



Part numbers

Size 10: UTS10DCG
Size 12: UTS12DCG
Size 14: UTS14DCG

Plug sealing cap



Part numbers

Size 10: UTS610DCG
Size 12: UTS612DCG
Size 14: UTS614DCG

Colour coding rings

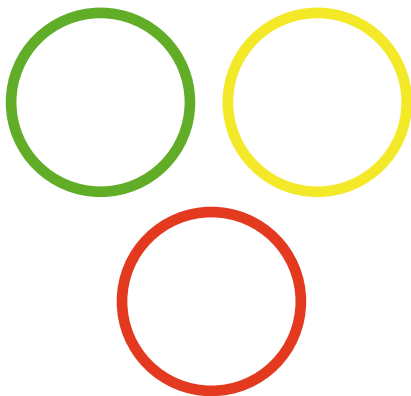

Part numbers for receptacle

Size 10: UTS710CCR*
Size 12: UTS712CCR*
Size 14: UTS714CCR*

* Add G for Green, Y for Yellow, R for Red

Part numbers for plug

Size 10: UTS610CCR*
Size 12: UTS612CCR*
Size 14: UTS614CCR*

* Add G for Green, Y for Yellow, R for Red

UTS : Your first choice in waterproof connectors !



What is sealing and how it is specified

- The connector's housing, sealing and locking mechanism protect the connection from external influences such as mechanical shocks, foreign bodies, humidity, dust, water and other fluids.
- The degree of protection is explained in IEC 60529, DIN EN60529 (DIN 40050) standards that categorize connections according to foreign body and water protection.
- The degree of protection is indicated by IP (International Protection) followed by 2 digits (See example below):

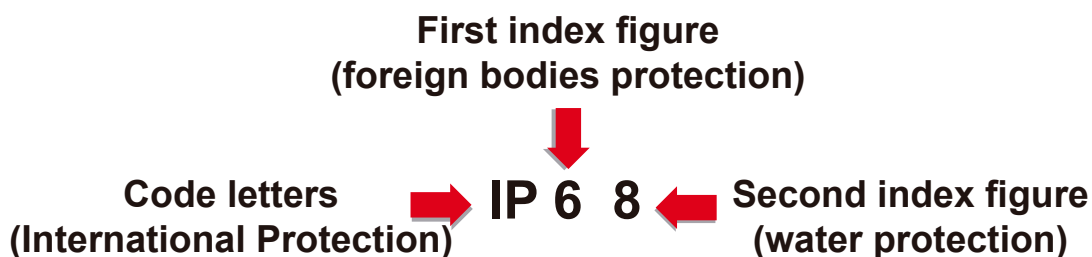

Index figure	Degree of protection	Index figure	Degree of protection
0	No protection against accidental contact. No protection against solid foreign bodies.	0	No protection against water.
1	Protection against contacts with any large area by hand and against large solid foreign bodies with a diameter bigger than 50mm.	1	Drip-proof. Protection against vertical water drips.
2	Protection against contacts with the fingers. Protection against solid foreign bodies with a diameter bigger than 12mm.	2	Drip-proof. Protection against water drips up to a 15° angle.
3	Protection against tools, wires or similar objects with a diameter bigger than 2.5mm.. Protection against small solid bodies with a diameter bigger than 2.5mm.	3	Spray-proof. Protection against diagonal water drips up to a 60° angle.
4	As 3 however diameter is bigger than 1mm.	4	Splash-proof. Protection against splashed water from all directions.
5	Full protection against contacts. Protection against interior injurious dust deposits.	5	Hise-proof. Protection against water (out of a nozzle) from all directions.
6	Total protection against contacts. Protection against penetration of dust.	6	Protection against temporary flooding.
		7	Protection against temporary immersions.
		8	Protection against water pressure. Pressure to be specified by supplier.
		9K	High pressure hose-proof. Protection against high pressure water (out of a nozzle) from all directions.

↓

UTS offers high sealing performance IP68 / IP69K...
Even in dynamic situations.

SOURIAU reserves the right to make any engineering refinements, alterations or improvements deemed necessary on its products.
The dimensions appearing in this catalogue are thus subject to change without notice. When dimensions are critical detailed drawings should be requested.

UTS : Your first choice in waterproof connectors !



Notes

A large grid of graph paper for taking notes, consisting of 20 columns and 30 rows of small squares.



Notes

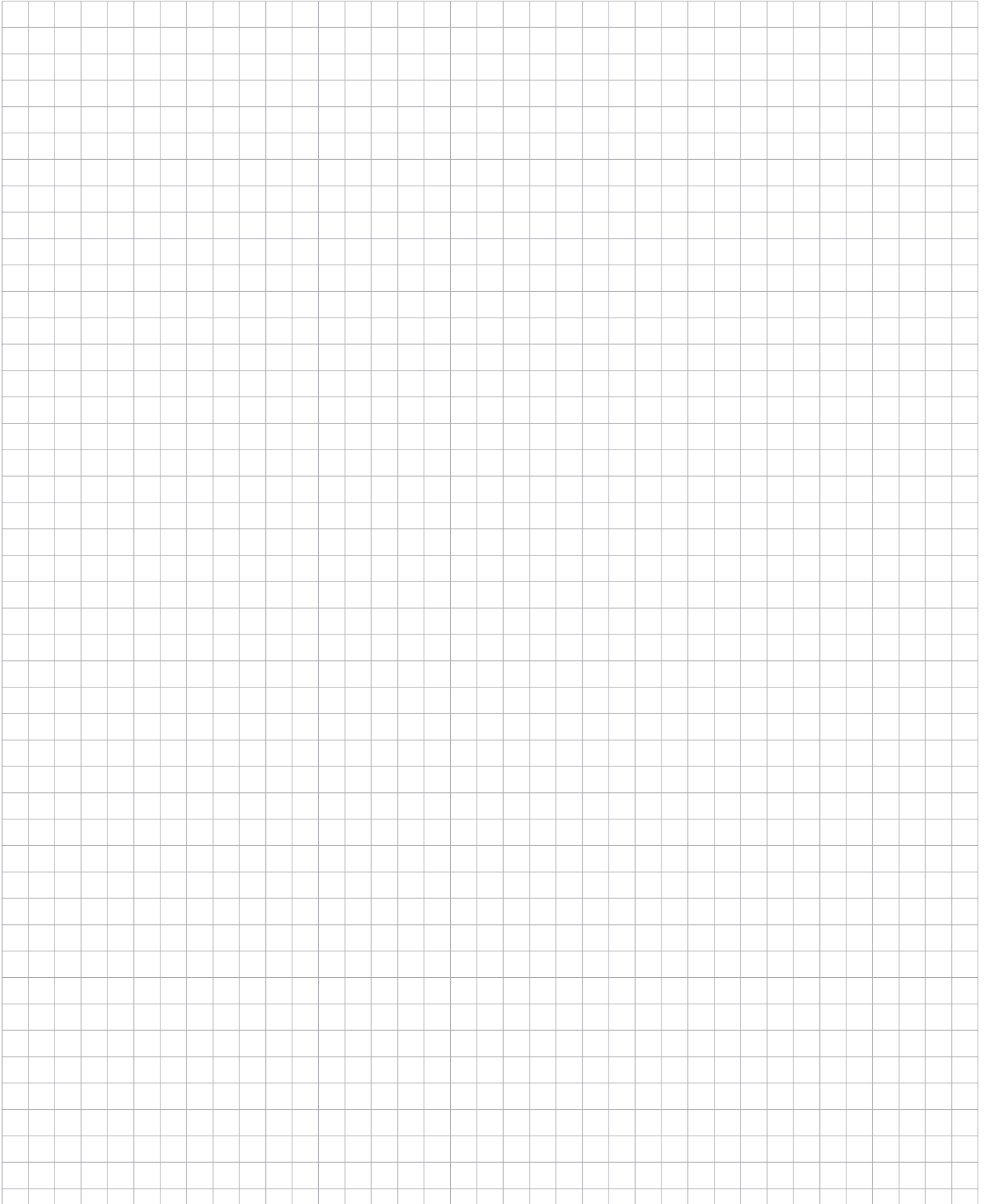



UTS - Suitable for a broad range of applications

Tunnel fans



Meteorological measurement systems



Traffic control



Its uses are endless!
here are a few...

Parking detection systems



Videosurveillance



Lifting equipments



Oceanographic instrumentations



Coast guarding equipments



Broadcasting systems



and there is more...:

- street maintenance,
- Wind mills,
- Off road equipment,
- Antenna dish,
- Solar technology,
- Machine tools,
- Lightning / theatre,
- Outdoor advertising,
- Food processing,
- Elevators & lifts,
- Measuring / Test / Inspection,
- Wheel chairs,
- Medical applications,
- etc...

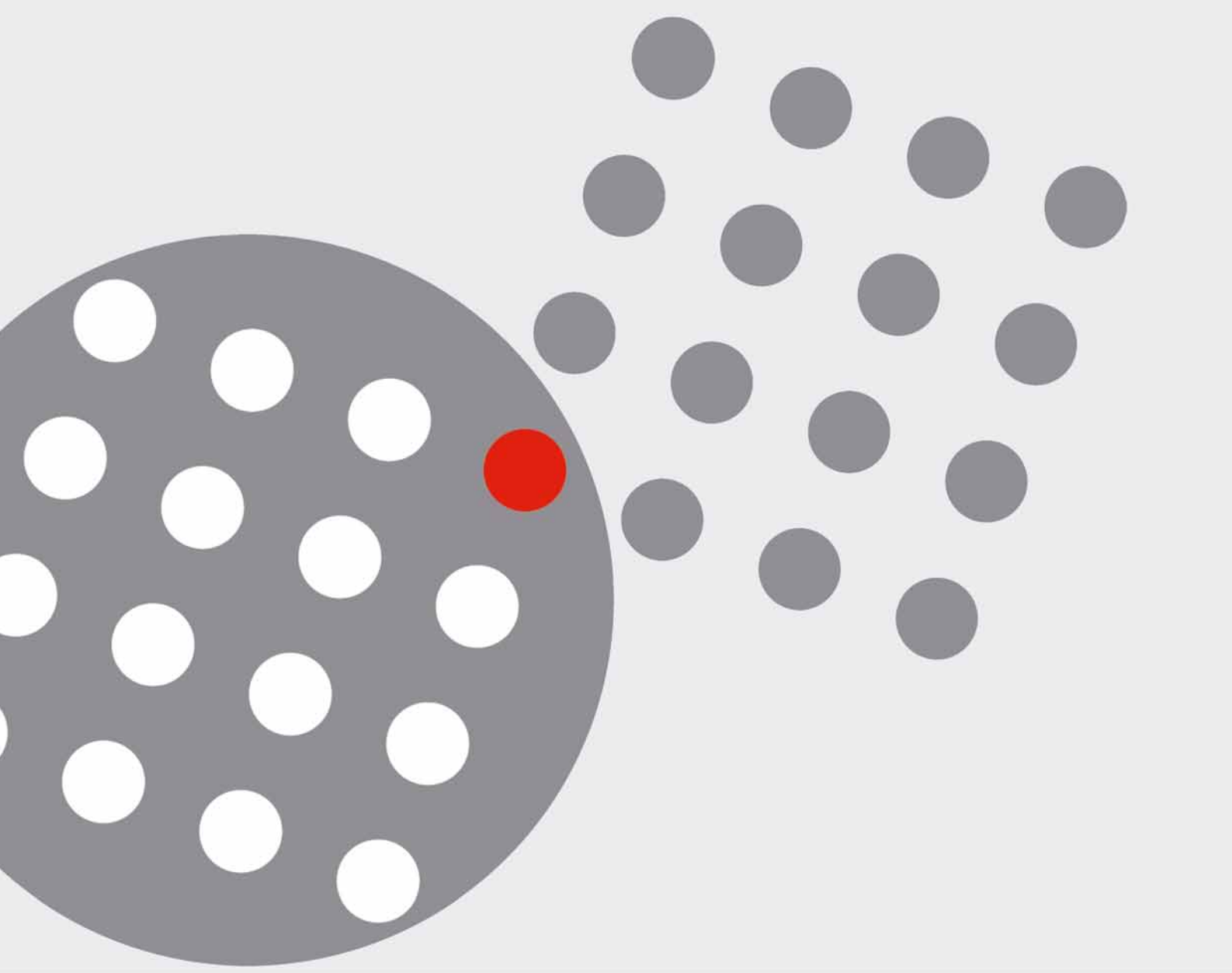

www.souriau.com

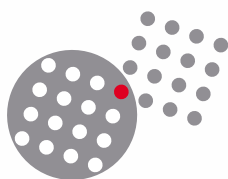

SOURIAU
Connection Technology